

CAUTION!
PRELIMINARY INFO ONLY
THE INFORMATION PRESENTED
IN THIS DIAGRAM IS NOT
GUARANTEED TO BE
COMPLETELY CORRECT

COLORS:

- B = BLACK
- G = GREEN
- K = PINK
- LG = LIGHT GREEN
- N = BROWN
- O = ORANGE
- P = PURPLE
- R = RED
- S = SLATE (GRAY)
- U = BLUE
- W = WHITE
- Y = YELLOW

FUSES

13	15	17	19	21	23
14	16	18	20	22	24
1	3	5	7	9	11
2	4	6	8	10	12

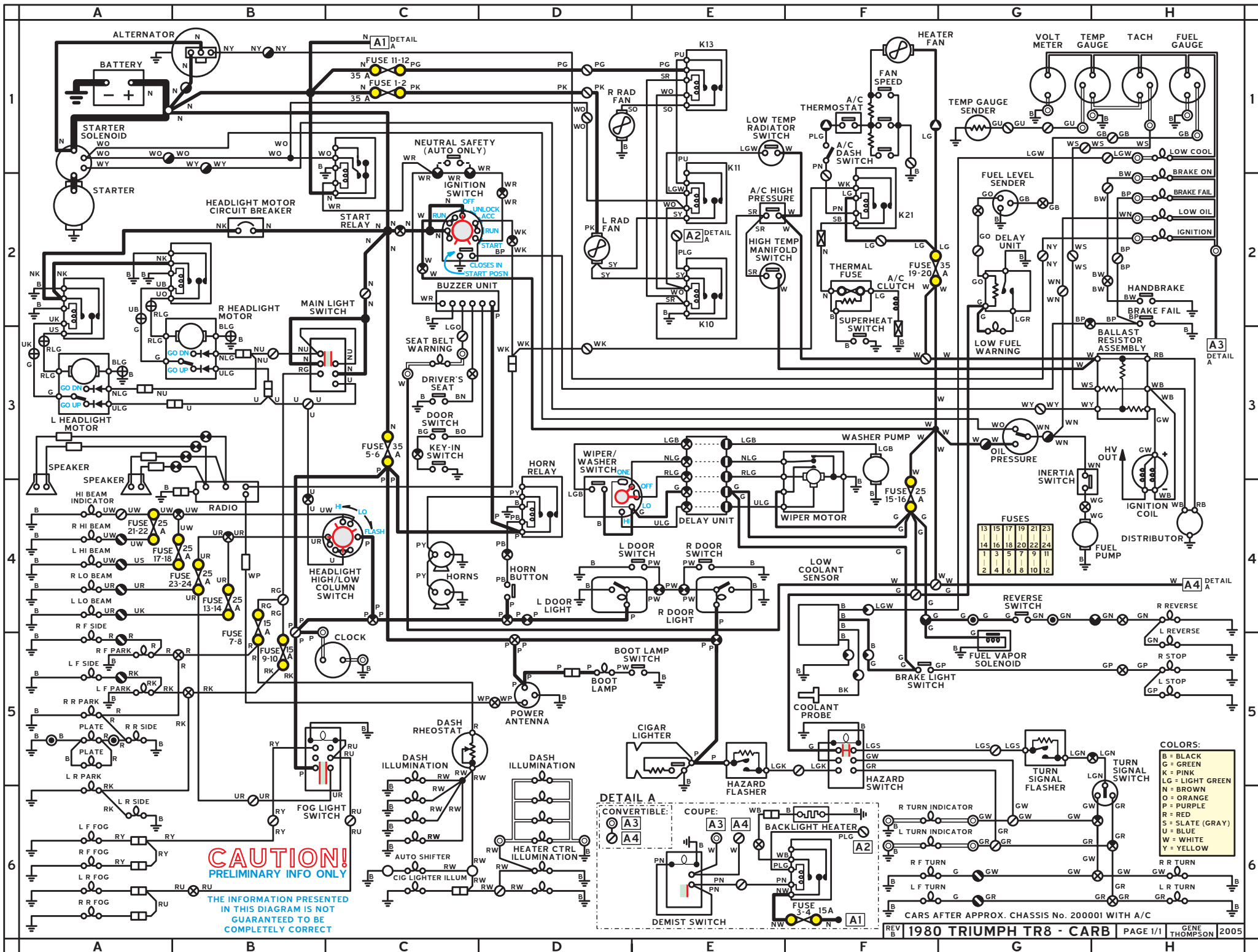

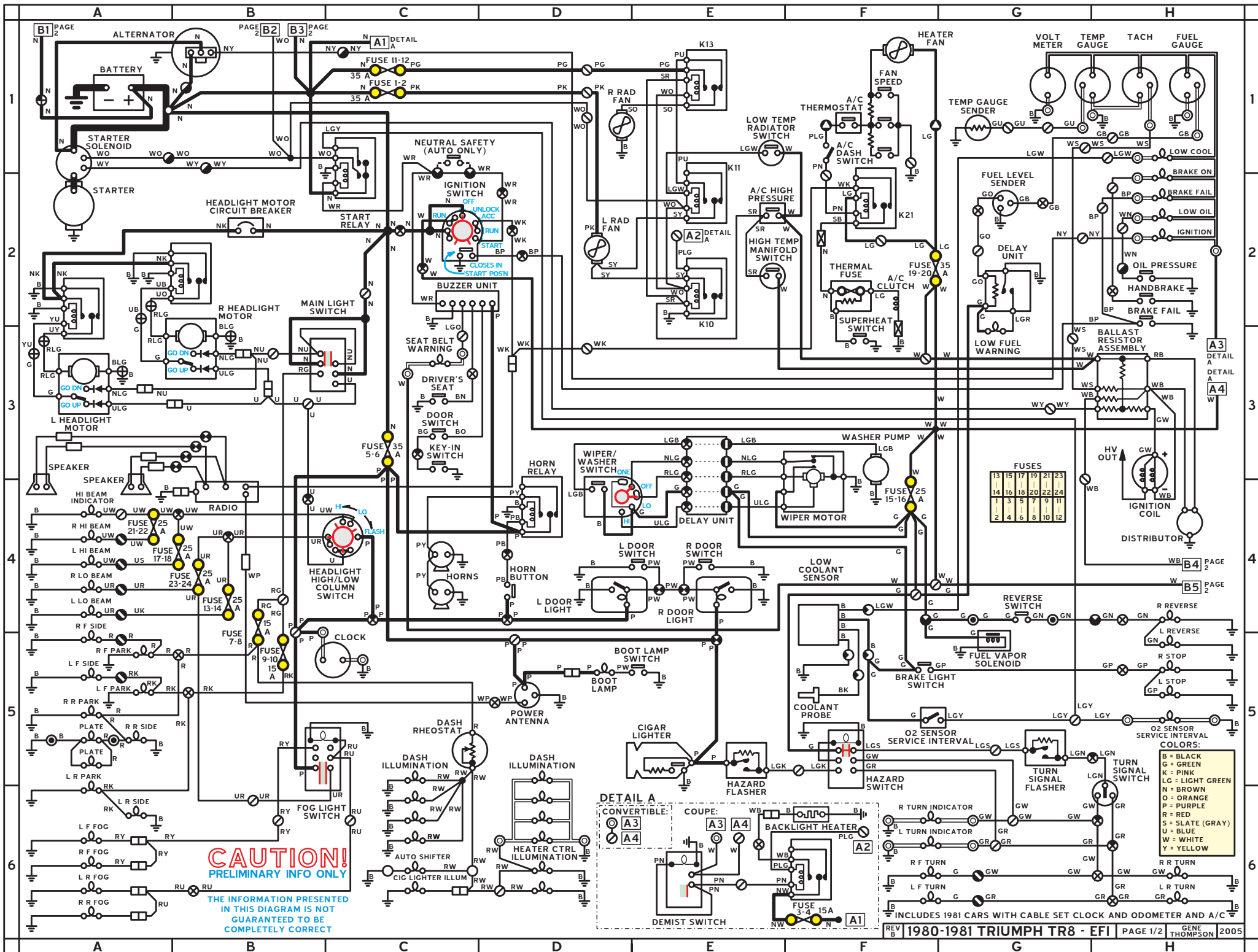

CAUTION!
PRELIMINARY INFO ONLY

THE INFORMATION PRESENTED
IN THIS DIAGRAM IS NOT
GUARANTEED TO BE
COMPLETELY CORRECT

13	15	17	19	21	23
14	16	18	20	22	24
1	3	5	7	9	11
2	4	6	8	10	12

- COLORS:**
- B = BLACK
 - G = GREEN
 - K = PINK
 - LG = LIGHT GREEN
 - N = BROWN
 - O = ORANGE
 - P = PURPLE
 - R = RED
 - S = SLATE (GRAY)
 - U = BLUE
 - W = WHITE
 - Y = YELLOW

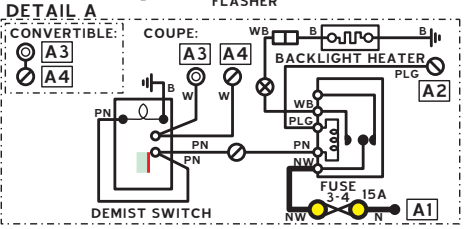

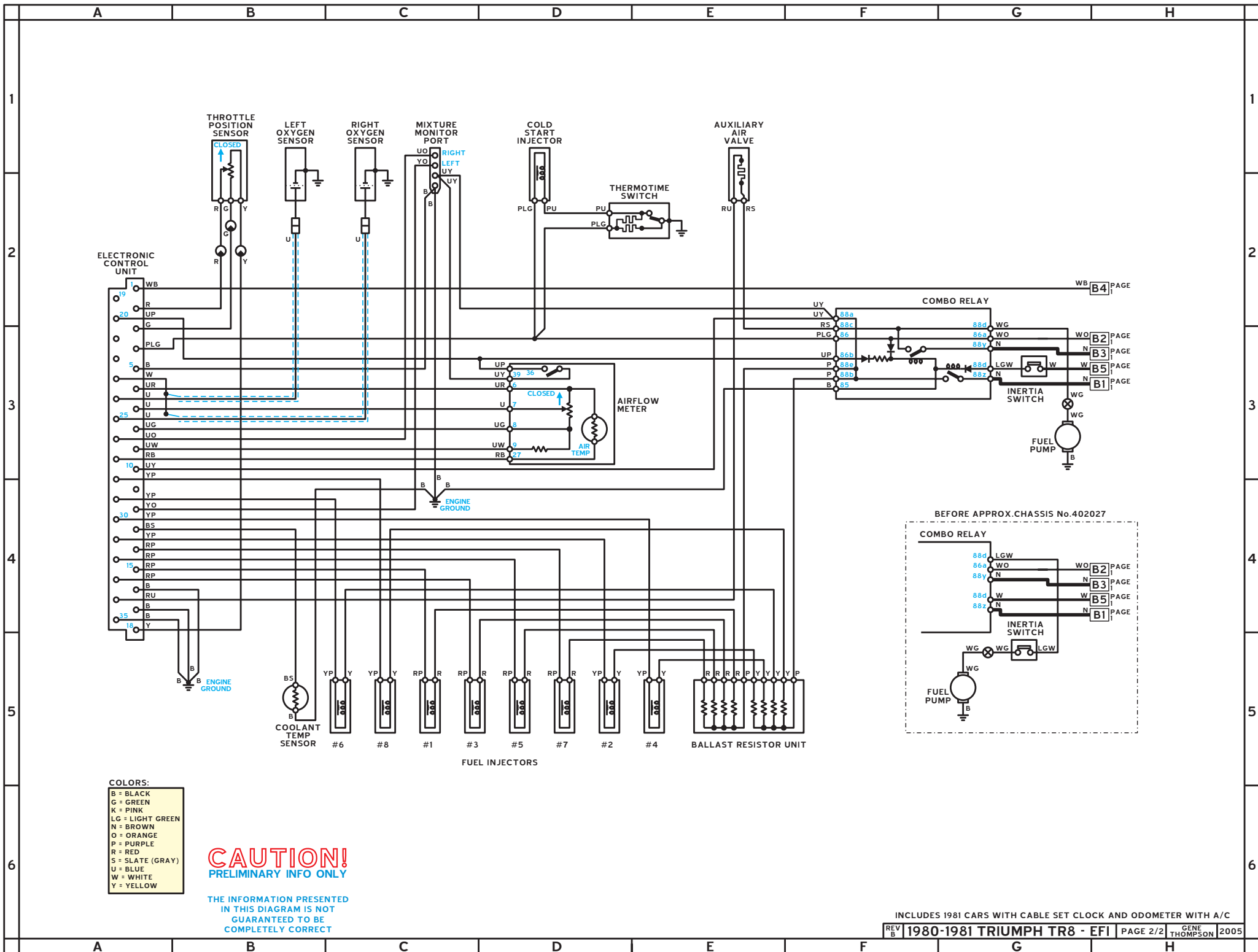

- COLORS:**
- B = BLACK
 - G = GREEN
 - K = PINK
 - LG = LIGHT GREEN
 - N = BROWN
 - O = ORANGE
 - P = PURPLE
 - R = RED
 - S = SLATE (GRAY)
 - U = BLUE
 - W = WHITE
 - Y = YELLOW

CAUTION!
PRELIMINARY INFO ONLY

THE INFORMATION PRESENTED
IN THIS DIAGRAM IS NOT
GUARANTEED TO BE
COMPLETELY CORRECT

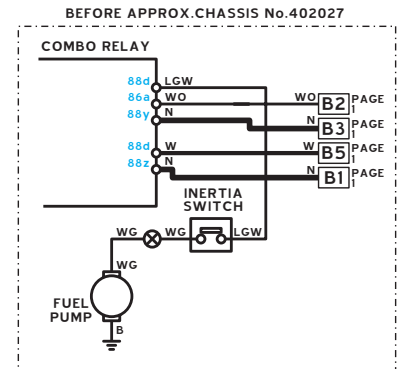

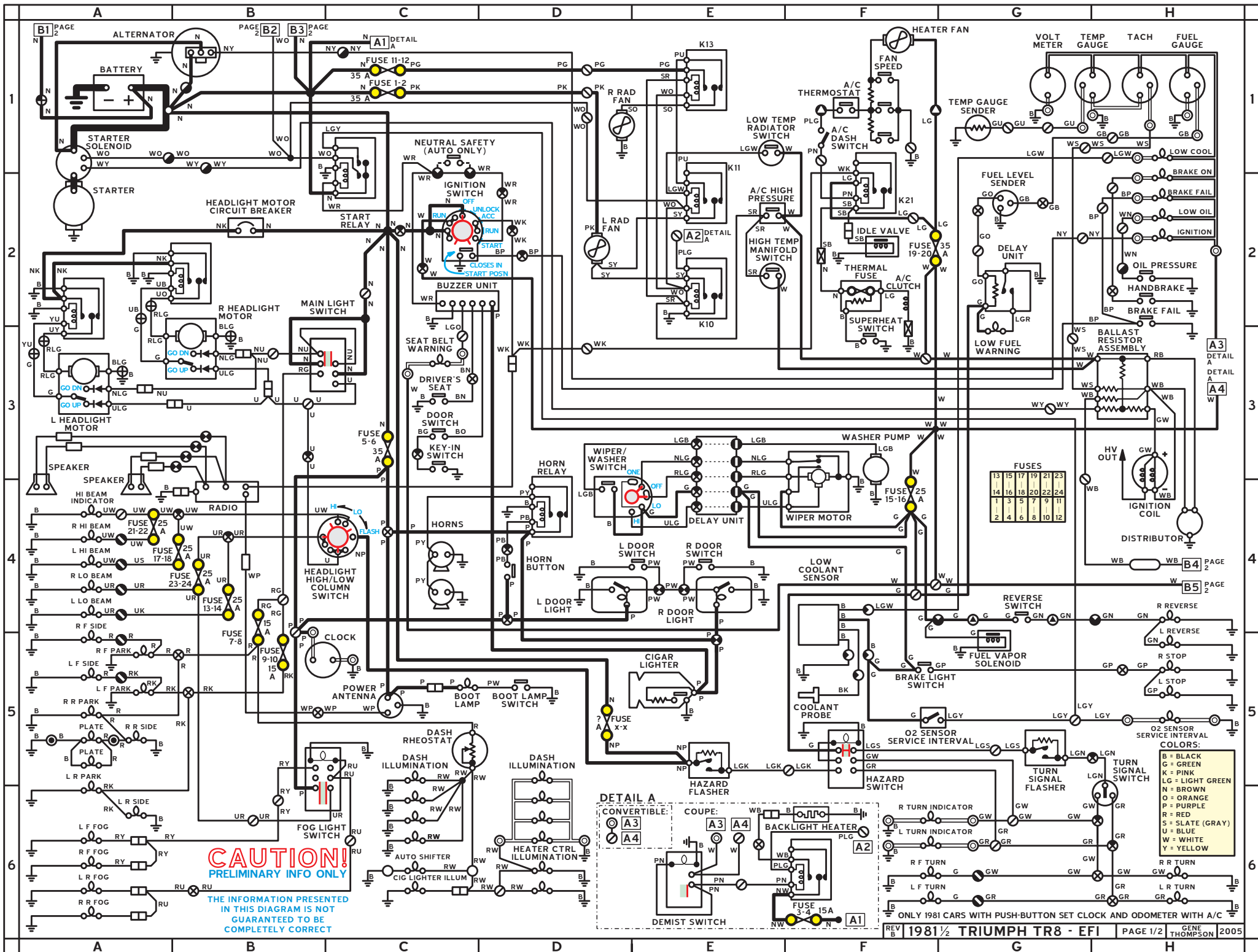

CAUTION!
 PRELIMINARY INFO ONLY
 THE INFORMATION PRESENTED
 IN THIS DIAGRAM IS NOT
 GUARANTEED TO BE
 COMPLETELY CORRECT

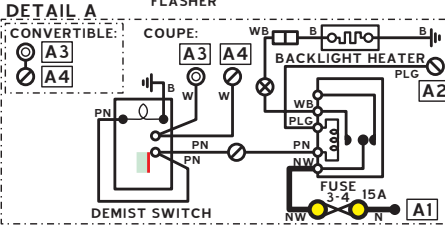

FUSES

13	15	17	19	21	23
14	16	18	20	22	24
1	3	5	7	9	11
2	4	6	8	10	12

COLORS:

- B = BLACK
- G = GREEN
- K = PINK
- LG = LIGHT GREEN
- N = BROWN
- O = ORANGE
- P = PURPLE
- R = RED
- S = SLATE (GRAY)
- U = BLUE
- W = WHITE
- Y = YELLOW

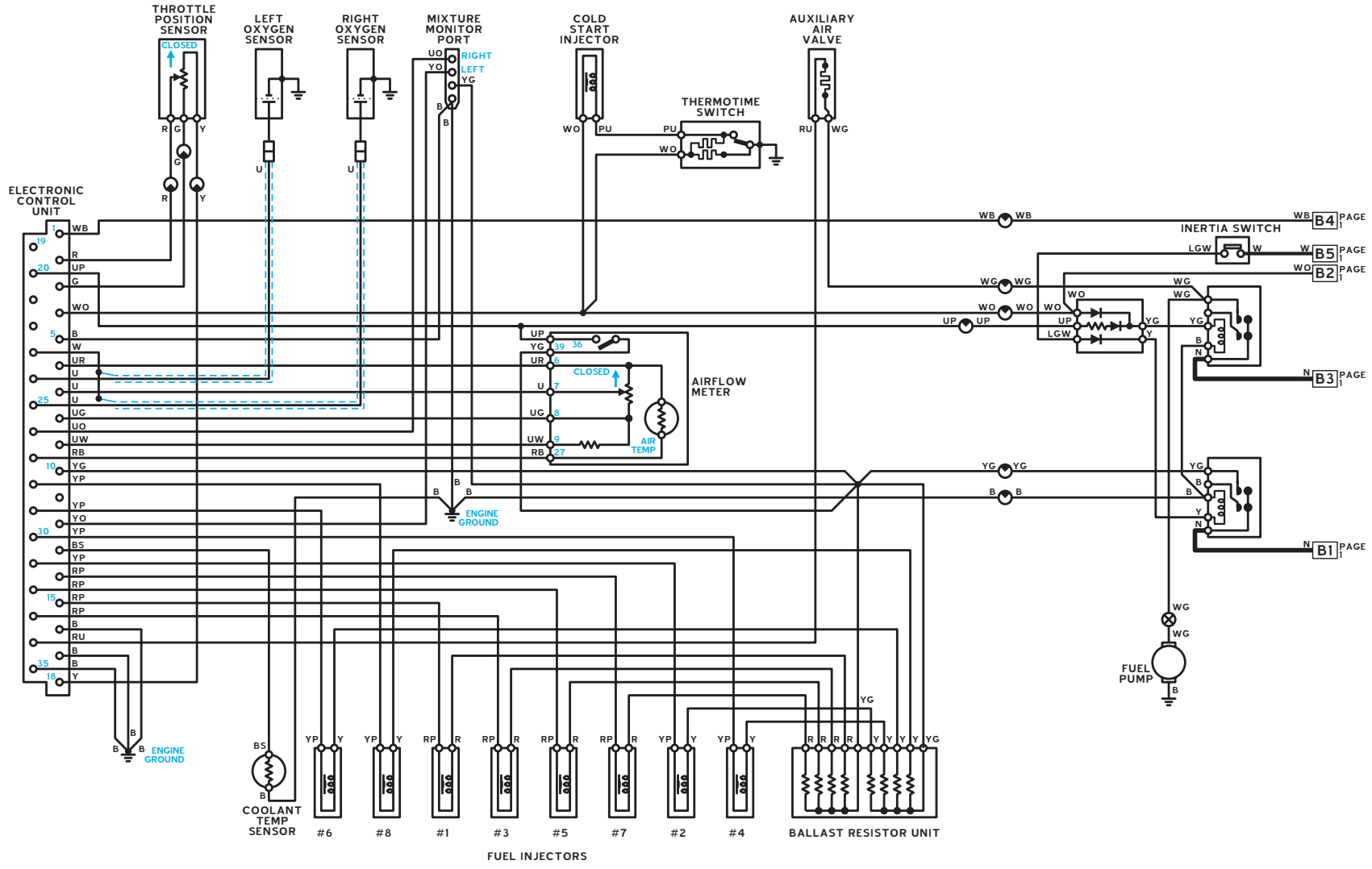

- COLORS:**
- B = BLACK
 - G = GREEN
 - K = PINK
 - LG = LIGHT GREEN
 - N = BROWN
 - O = ORANGE
 - P = PURPLE
 - R = RED
 - S = SLATE (GRAY)
 - U = BLUE
 - W = WHITE
 - Y = YELLOW

CAUTION!
PRELIMINARY INFO ONLY

THE INFORMATION PRESENTED
IN THIS DIAGRAM IS NOT
GUARANTEED TO BE
COMPLETELY CORRECT

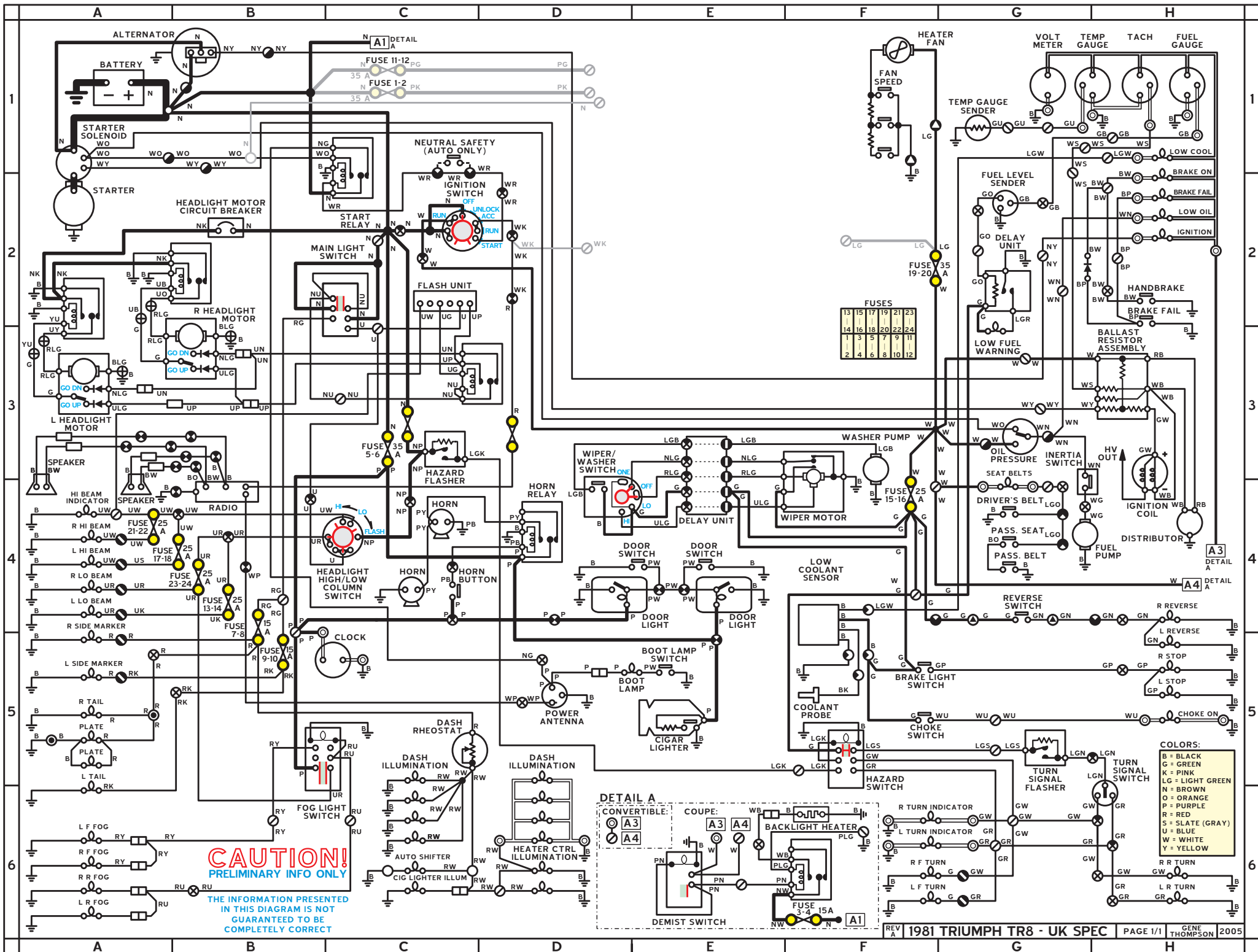

CAUTION!
 PRELIMINARY INFO ONLY
 THE INFORMATION PRESENTED
 IN THIS DIAGRAM IS NOT
 GUARANTEED TO BE
 COMPLETELY CORRECT

FUSES	
13	15
14	16
1	3
2	4
5	6
7	8
9	10
11	12
17	19
20	22
23	24

COLORS:
 B = BLACK
 G = GREEN
 K = PINK
 LG = LIGHT GREEN
 N = BROWN
 O = ORANGE
 P = PURPLE
 R = RED
 S = SLATE (GRAY)
 U = BLUE
 W = WHITE
 Y = YELLOW

